

Light quality:

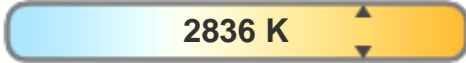

Color temperature:



Output: 300 lm

Peak: 80,0 cd

Power: 6,6 W

235V @ 0,028A



Beam angle

126,2°

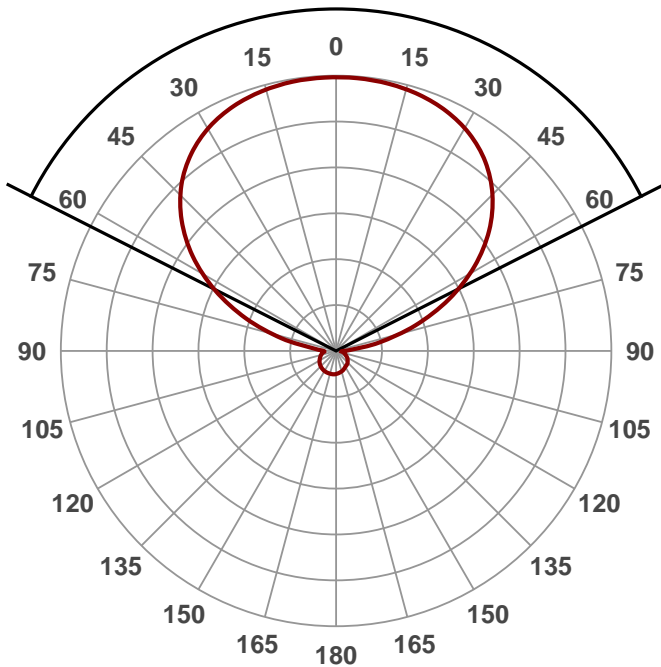

Product name:

Date and time:

31-10-2016 14:20:49

Color



**CIE1931
x: 0,447
y: 0,404**

Spectra

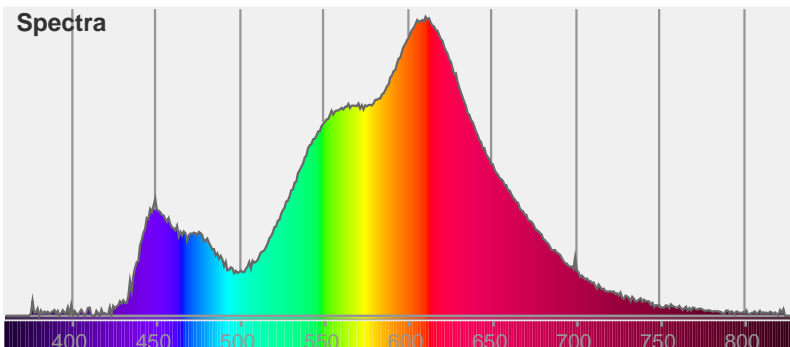

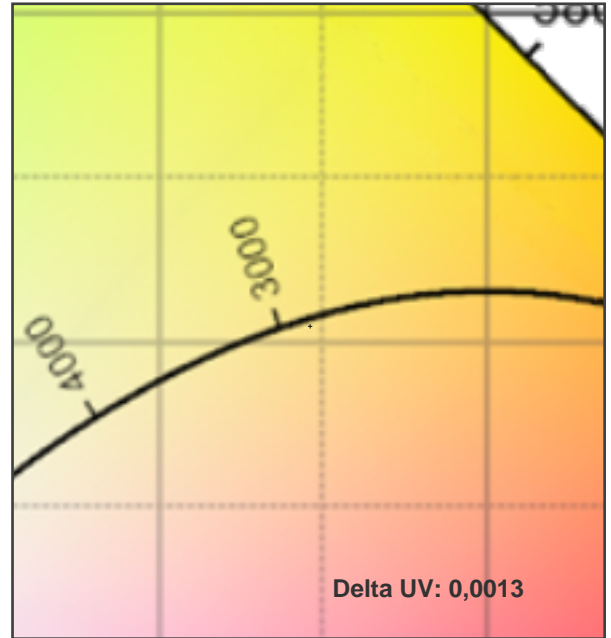
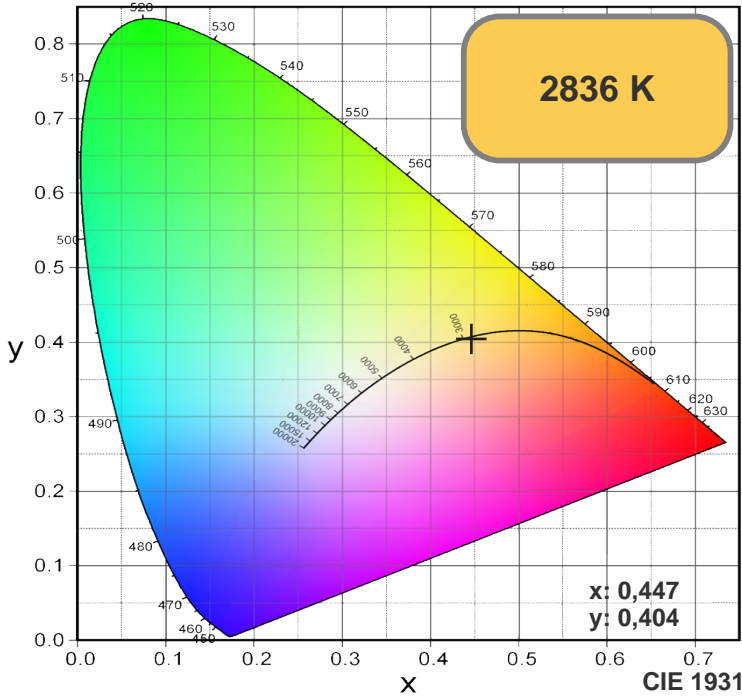

TM30: 77,8

CRI: 78,7 (R1-R8)

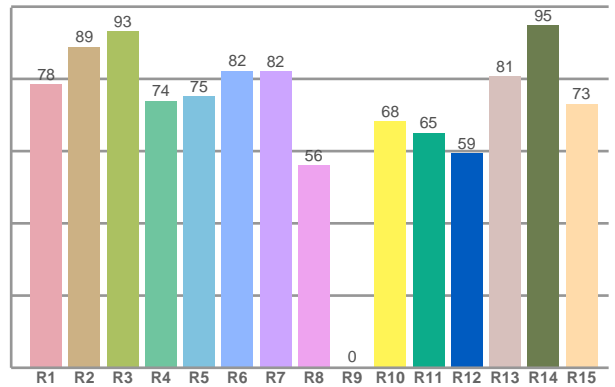
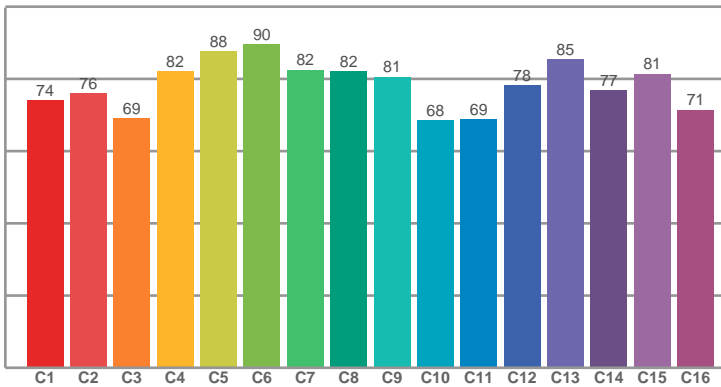

CRI R values, only R1-R8 are used to calculate final CRI value

R1	R2	R3	R4	R5	R6	R7	R8	R9	R10	R11	R12	R13	R14	R15
78,40	88,86	93,14	73,90	75,09	82,21	82,11	56,09	0,25	68,19	65,03	59,27	80,78	94,87	73,09

TM30 C values, 16 binned values out of total of 99 C values

C1	C2	C3	C4	C5	C6	C7	C8	C9	C10	C11	C12	C13	C14	C15	C16
74,05	75,90	68,98	82,11	87,52	89,54	82,46	82,08	80,54	68,48	68,72	78,28	85,42	76,79	81,39	71,44

CQS Q values

Q1	Q2	Q3	Q4	Q5	Q6	Q7	Q8	Q9	Q10	Q11	Q12	Q13	Q14	Q15
77,11	95,13	77,22	71,39	74,99	75,06	74,28	80,63	94,36	81,34	75,92	75,60	77,39	69,68	72,18

CQS: 76,9

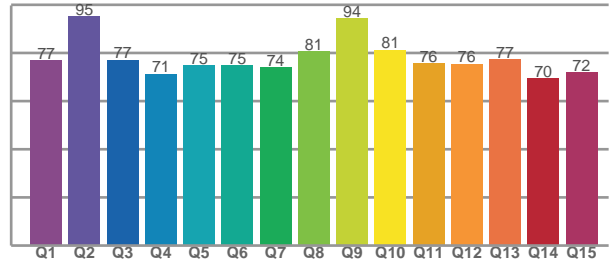

Color parameters

CCT	CRI	CRI R9	TM30 Rf	TM30 Rg	CQS	x	y	u	v	Duv
2836 K	78,7	0,3	77,8	94,7	76,9	0,4	0,4	0,3	0,3	0,0013

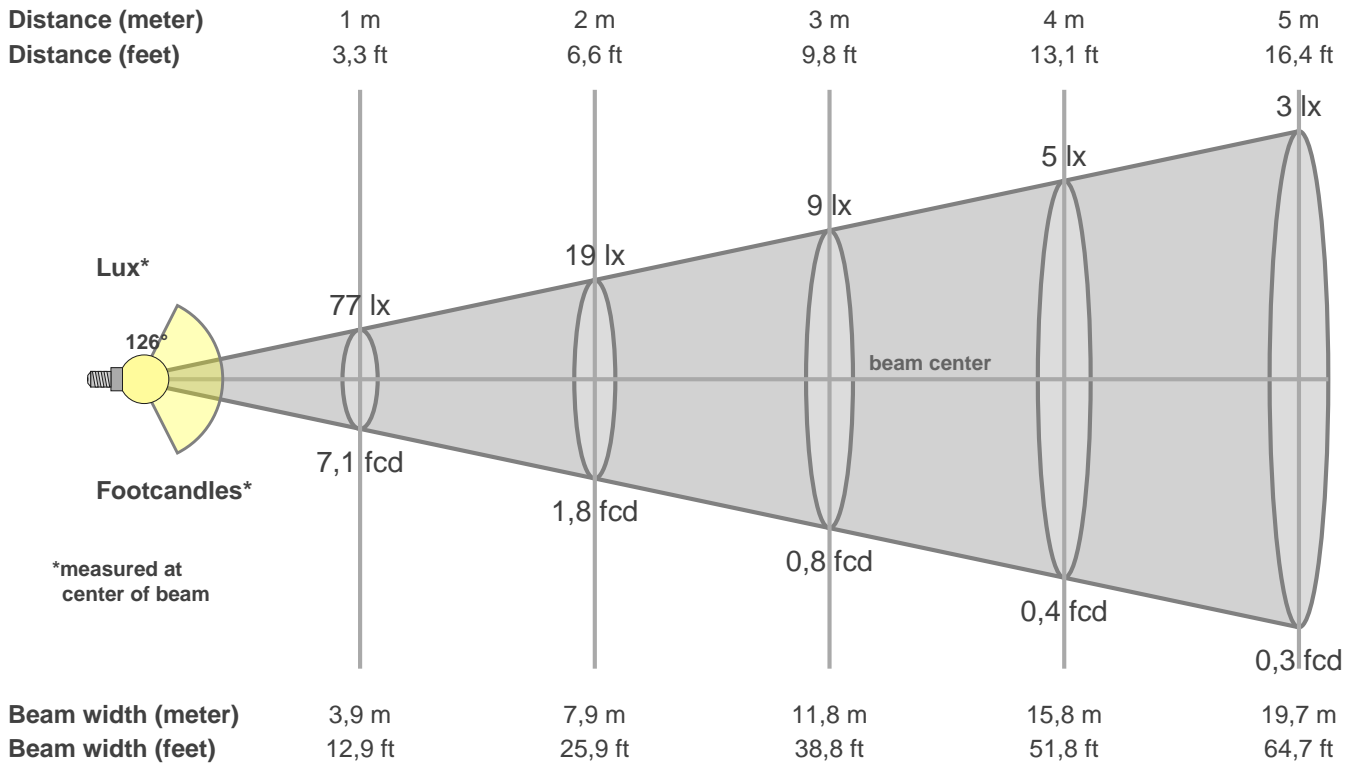

Intensities in 0° c-plane

0°	5°	10°	15°	20°	25°	30°	35°	40°	45°	50°	55°	60°	65°	70°	75°	80°	85°	90°	95°
76,5	76,4	76,2	75,7	74,8	73,5	71,7	69,1	65,7	61,4	56,3	50,0	42,9	35,2	27,1	18,9	11,4	5,7	3,6	3,7
100%	100%	100%	99%	98%	96%	94%	90%	86%	80%	74%	65%	56%	46%	35%	25%	15%	7%	5%	5%

Intensities in 0° c-plane

0°	5°	10°	15°	20°	25°	30°	35°	40°	45°	50°	55°	60°	65°	70°	75°	80°	85°	90°	95°
76,5	76,4	76,2	75,7	74,8	73,5	71,7	69,1	65,7	61,4	56,3	50,0	42,9	35,2	27,1	18,9	11,4	5,7	3,6	3,7
100%	100%	100%	99%	98%	96%	94%	90%	86%	80%	74%	65%	56%	46%	35%	25%	15%	7%	5%	5%

Intensities in 180° c-plane

0°	5°	10°	15°	20°	25°	30°	35°	40°	45°	50°	55°	60°	65°	70°	75°	80°	85°	90°	95°
76,5	76,5	76,2	75,7	74,9	73,7	71,9	69,3	66,0	61,8	56,4	50,2	43,1	35,3	26,9	18,7	11,0	4,9	2,5	1,7
100%	100%	100%	99%	98%	96%	94%	91%	86%	81%	74%	66%	56%	46%	35%	24%	14%	6%	3%	2%

Intensities in 180° c-plane

0°	5°	10°	15°	20°	25°	30°	35°	40°	45°	50°	55°	60°	65°	70°	75°	80°	85°	90°	95°
76,5	76,5	76,2	75,7	74,9	73,7	71,9	69,3	66,0	61,8	56,4	50,2	43,1	35,3	26,9	18,7	11,0	4,9	2,5	1,7
100%	100%	100%	99%	98%	96%	94%	91%	86%	81%	74%	66%	56%	46%	35%	24%	14%	6%	3%	2%

Beam angle 50%	Field angle 10%	Cutoff angle 2,5%	Intensity ratio in 120° cone	Intensity ratio in 90° cone
126,2°	165,4°	360,0°	69,2%	45,2%