

Light efficiency:



Light quality:



Color temperature:

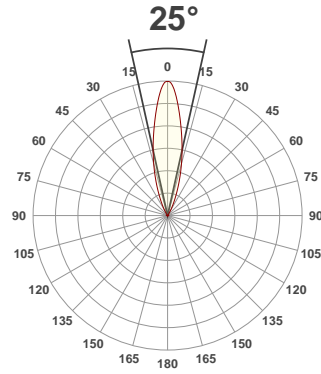
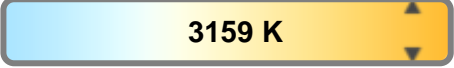

Product name:

knick small 25deg 3000K

Item number:

Date and time:

1/02/2020 14:19:27

Output: 683 Lumen Power consumption: 9,6

Spectral distribution

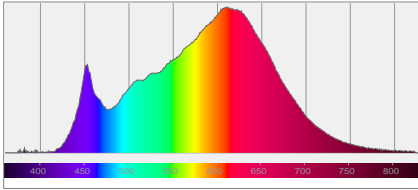

Color coordinates

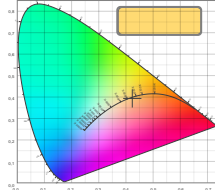

White color point

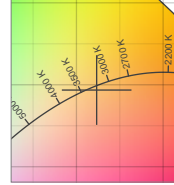

CRI R values

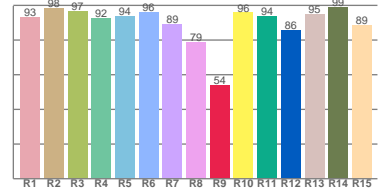

Color temperature	Color rendering index	Red component	Color fidelity	Color gamut	Color quality scale	Color coordinate cie 1931	Color coordinate cie 1931	Color coordinate	Color coordinate	Color deviation from black body
CCT	CRI	CRI R9	TM30 Rf	TM30 Rg	CQS	x	y	u	v	Δuv
3159 K	92,3	54,0	90,6	98,5	90,7	0,423	0,394	0,246	0,343	-0,0023

Beam details

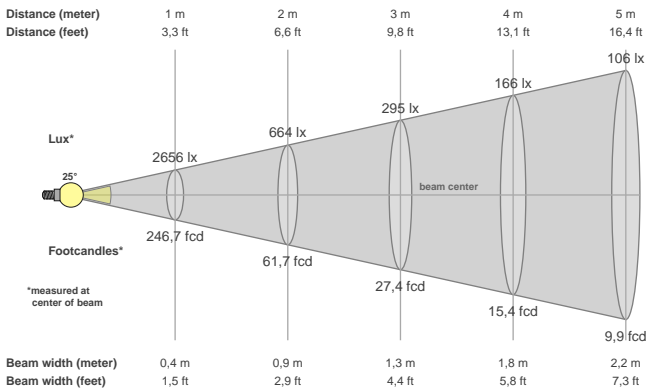

Beam angles

Beam angle 50%	Field angle 10%	Cutoff angle 2,5%
25°	51,3°	64,1°

Beam intensities

Peak intensity	Int. ratio in 120° cone	Int. ratio in 90° cone
2656 cd	96,3%	95,5%

Beam intensities from 1-20m

1m	2m	3m	4m	5m	6m	7m	8m	9m	10m	11m	12m	13m	14m	15m	16m	17m	18m	19m	20m
3,3ft	6,6ft	9,8ft	13,1ft	16,4ft	19,7ft	23ft	26,2ft	29,5ft	32,8ft	36,1ft	39,4ft	42,7ft	45,9ft	49,2ft	52,5ft	55,8ft	59,1ft	62,3ft	65,6ft
2656lx	664lx	295lx	166lx	106lx	74lx	54lx	41lx	33lx	27lx	22lx	18lx	16lx	14lx	12lx	10lx	9lx	8lx	7lx	7lx
246,7fcd	61,7fcd	27,4fcd	15,4fcd	9,9fcd	6,9fcd	5fcd	3,9fcd	3fcd	2,5fcd	2fcd	1,7fcd	1,5fcd	1,3fcd	1,1fcd	1fcd	0,9fcd	0,8fcd	0,7fcd	0,6fcd

Power scope

--	--	--	--	--	--	--	--	--	--	--	--	--	--	--	--	--	--	--	--	--

Power	Power factor	Power frequency
9,6 W	0,88	{FREQ } Hz

Nominal voltage	Voltage	Current
230 V	48,0 V	0,200 A